

HSK-A /ER11 精密級刀桿

HSK-A precision collect holders

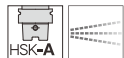

Product information:

- HSK-A according to ISO 12164-1 / DIN 69893-1
- balancing quality: G 2.5 / 25,000 rpm or rev. < 1 gmm
- for ER11 high-precision collet holders (similar to ISO 15488), art. no. 4574 and 4575
- **concentricity overall system < 3µm**
(at 3 x clamping-Ø max. 50 mm)
- observe maximum tightening torque values of clamping nut
clamping Ø 1.0 - 2.5 = 7 Nm **鎖固扭力 1.0 - 2.5 = 7 Nm**
clamping Ø 3.0 - 7.5 = 10 Nm **鎖固扭力 3.0 - 7.5 = 10 Nm**
- without adjusting screw

Scope of delivery:

- incl. clamping nut art. no. 4573

suitable accessories separately available:

- collet chucks art. no. 4574 or 4575 (sealed)
- roller keys art. no. 4994
- roller spanner insert, art. no. 4995 for optimum operation
- torque wrench art. no. 4981 5,025 and coolant transfer unit, art. no. 4949

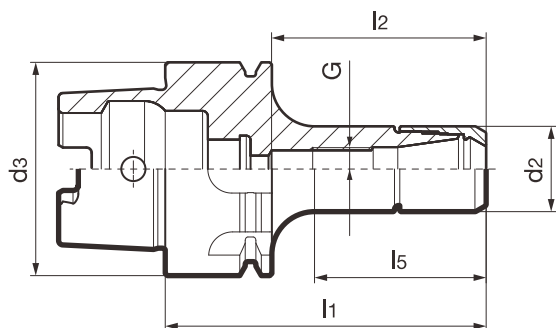

HSK-A / ER11 精密級刀桿



								Article no.	4476	
d3	Size	Ø-range	d2 mm	l1 mm	l2 mm	l5 mm	1/min	G	Order no.	價格
HSK-A 32	ER11	1.0-7.0	16	40	24	20	50000		4476 11.032	27,200
HSK-A 40	ER11	1.0-7.0	16	60	40	40	42000	M 8 X1	4476 11.040	23,300
HSK-A 40	ER11	1.0-7.0	16	130	75	110	27000	M 8 X1	4476 11.140	25,600
HSK-A 50	ER11	1.0-7.0	16	130	60	104	27000	M 8 X1	4476 11.050	18,700
HSK-A 63	ER11	1.0-7.0	16	70	48	34	25000	M 8 X1	4476 11.063	26,800
HSK-A 63	ER11	1.0-7.0	16	100	78	64	25000	M 8 X1	4476 11.163	18,700
HSK-A 63	ER11	1.0-7.0	16	130	108	94	25000	M 8 X1	4476 11.263	23,100
HSK-A 63	ER11	1.0-7.0	16	160	138	124	25000	M 8 X1	4476 11.363	25,200

HSK-E / ER11精密級刀桿

HSK-E precision collet holders



Product information:

- HSK-E according to DIN 69893-5, without access hole in taper
- balancing quality: G 2.5 / 25,000 rpm
or rev. < 1 gmm
- for ER11 high-precision collet holders (similar to ISO 15488), art. no. 4574 and 4575
- **concentricity overall system <math>< 3\mu\text{m}</math>**
(at 3 x clamping- \varnothing max. 50 mm)
- observe maximum tightening torque values of clamping nut
clamping \varnothing 1.0 - 2.5 = 7 Nm **鎖固扭力 1.0 - 2.5 = 7 Nm**
clamping \varnothing 3.0 - 7.5 = 10 Nm **鎖固扭力 3.0 - 7.5 = 10 Nm**
- without adjusting screw

Scope of delivery:

- incl. clamping nut art. no. 4573

suitable accessories separately available:

- collet chucks art. no. 4574 or 4575 (sealed)
- roller keys art. no. 4994
- roller spanner insert, art. no. 4995 for optimum operation
- torque wrenches art. no. 4981 5.025
- coolant supply set art. no. 4949

HSK-E 全圓無缺口型

ER11精密級刀桿 高速加工機使用

高速加工機例如：Roku Roku、YASDA

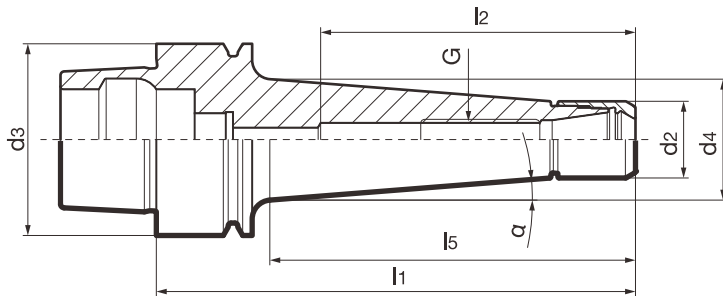

										Article no.	4475	
d3	Size	\varnothing -range	d2 mm	d4 mm	l1 mm	l2 mm	l5 mm	α °	l/min	G	Order no.	價格
HSK-E 25	ER11	1,0-7,5	16	20.0	35	22	22.0		60000		4475 11.025	21,900
HSK-E 32	ER11	1,0-7,5	16	17.5	50	34	27.5	4.5	50000	M 8 X1	4475 11.032	21,500
HSK-E 40	ER11	1,0-7,5	16	17.0	50	31	22.5	4.5	42000	M 8 X1	4475 11.040	18,900
HSK-E 40	ER11	1,0-7,5	16	25.5	100	65	75.5	4.5	40000	M 8 X1	4475 11.140	21,700
HSK-E 40	ER11	1,0-7,5	16	30.5	130	65	108.0	4.5	35000	M 8 X1	4475 11.240	20,800
HSK-E 40	ER11	1,0-7,5	16	32.0	160	65	139.0	4.5	27000	M 8 X1	4475 11.340	24,200
HSK-E 50	ER11	1,0-7,5	16	18.0	60	37	30.0	4.5	30000	M 8 X1	4475 11.050	27,700
HSK-E 50	ER11	1,0-7,5	16	24.5	100	73	70.0	4.5	30000	M 8 X1	4475 11.150	30,500

ER11 精密級筒夾 2 μm

Precision collets for precision collet holders

Product information:

- precision collet holders, sealed ER11 sim. ISO 15488
- especially for precision collet holders art. nr. 4475 and 4476
- for tool shanks h10
- **concentricity < 2 μm**
- no clamping bridging
- observe maximum tightening torque values of clamping nut
clamping Ø 1.0 - 2.5 = 7 Nm 鎖固扭力 1.0 - 2.5 = 7 Nm
clamping Ø 3.0 - 7.5 = 10 Nm 鎖固扭力 3.0 - 7.5 = 10 Nm

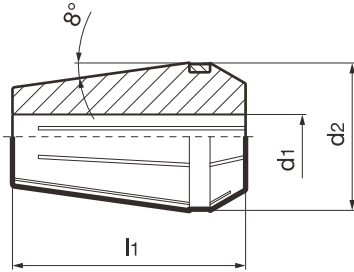

ER11 精密級筒夾 2 μm



				Article no.	4574	
Size	d1 mm	d2 mm	l1 mm	Order no.	價格	
ER11	1.00	11.3	18.00	4574 1.011	7,200	
ER11	1.50	11.3	18.00	4574 1.511	7,200	
ER11	2.00	11.3	18.00	4574 2.011	5,600	
ER11	2.50	11.3	18.00	4574 2.511	5,600	
ER11	3.00	11.3	18.00	4574 3.011	4,700	
ER11	3.50	11.3	18.00	4574 3.511	4,700	
ER11	4.00	11.3	18.00	4574 4.011	4,700	
ER11	4.50	11.3	18.00	4574 4.511	4,700	
ER11	5.00	11.3	18.00	4574 5.011	4,700	
ER11	5.50	11.3	18.00	4574 5.511	4,700	
ER11	6.00	11.3	18.00	4574 6.011	4,700	
ER11	6.50	11.3	18.00	4574 6.511	4,700	
ER11	7.00	11.3	18.00	4574 7.011	4,700	

ER11 精密級筒夾 Sealed 油封型 2 μm

Precision collets for precision collet holders, sealed

Product information:

- precision collet holders, sealed ER11 sim. ISO 15488
- especially for precision collet holders art. nr. 4475 and 4476
- for tool shanks h8
- **concentricity < 2 μm**
- no clamping bridging
- observe maximum tightening torque values of clamping nut
clamping Ø 1.0 - 2.5 = 7 Nm 鎖固扭力 1.0 - 2.5 = 7 Nm
clamping Ø 3.0 - 7.5 = 10 Nm 鎖固扭力 3.0 - 7.5 = 10 Nm

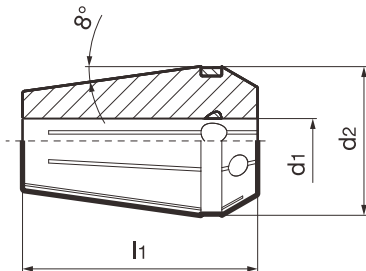

ER11 精密級筒夾 Sealed 油封型 2 μm



				Article no.	4575	
Size	d1 mm	d2 mm	l1 mm	Order no.	價格	
ER11	3	11.3	18.00	4575 3.011	6,700	
ER11	4	11.3	18.00	4575 4.011	6,700	
ER11	5	11.3	18.00	4575 5.011	6,700	
ER11	6	11.3	18.00	4575 6.011	6,700	

精密級刀桿用螺帽

Clamping nuts for precision collet holders

Product information:

- especially for precision collet holders
art. nr. 4475 and 4476
- for ER11 high-precision collet holders (similar to ISO 15488), art. no. 4574 and 4575

suitable accessories separately available:

- roller keys art. no. 4994 11.000
- torque wrenches art. no. 4981 5.025

精密級刀桿用螺帽

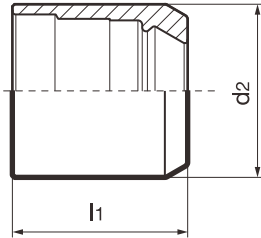

				Article no.	4573	
Nominal size	Ø-range	d2 mm	l1 mm	Order no.	價格	
ER11	1.0-7.0	16.00	16.200	4573 11.000	4,000	

ER11 筒夾 扭力扳手

Roller spanner for precision collet holders

Product information:

- especially for precision collet holders
art. nr. 4475 and 4476
- observe maximum tightening torque values of clamping nut
clamping Ø 1.0 - 2.5 = 7 Nm
clamping Ø 3.0 - 7.5 = 10 Nm

鎖固扭力 1.0 - 2.5 = 7 Nm
鎖固扭力 3.0 - 7.5 = 10 Nm

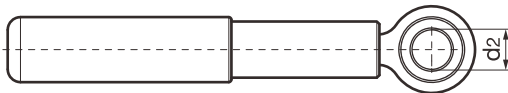

			Article no.	4994	
Nominal size	d2 mm		Order no.	價格	
ER11	16.00		4994 11.000	6,900	

ER11 筒夾 扭力扳手頭

Roller spanner insert for torque wrench

Product information:

- for Torque wrenches art. no. 4981
 - especially for precision collet holders art. nr. 4475 and 4476
 - observe maximum tightening torque values of clamping nut
clamping \varnothing 1.0 - 2.5 = 7 Nm
clamping \varnothing 3.0 - 7.5 = 10 Nm
- 鎖固扭力 1.0 - 2.5 = 7 Nm**
鎖固扭力 3.0 - 7.5 = 10 Nm

suitable accessories separately available:

- torque wrenches art.no. 4981 5.025

ER11 筒夾 扭力扳手頭

需搭配 #4981 5.025 扭力扳手使用

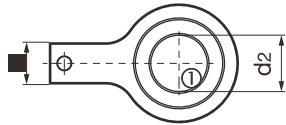

			Article no.	4995	
Nominal size	d2 mm	Drive ■	Order no.	價格	
ER11	16	9x12	4995 11.000	6,900	

扭力扳手

Torque wrenches

Product information:

- for roller spanner insert, art. no. 4995
- torque adjustable: 5-25 Nm
- with square socket
- triggering accuracy $\pm 3\%$ of scale value

需搭配 #4995 扭力扳手頭使用
扭力調整範圍 5-25 Nm

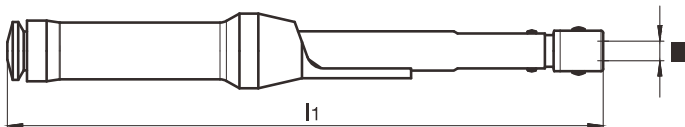

			Article no.	4981	
Torque Nm	d1 mm	Drive ■	Order no.	價格	
5-25	273	9x12	4981 5.025	14,500	